



Automation for a Changing World

Delta Temperature Controller DT Series



www.deltaww.com

 **DELTA**
Smarter. Greener. Together.

Features

Many Sizes Available:

- From 48x24 mm to 96x96 mm, all panel sizes comply with international standards

Quality Assurance:

- All temperature controllers adopt an isolated switching power supply
- 100 ~ 240 V_{AC} / 24 V_{DC} input power supply applicable in all countries of the world
- CE, UL and C-Tick certified



Supports Various Sensors:

- Various built-in sensor input modes: Thermocouple, platinum RTD or linear voltage/current

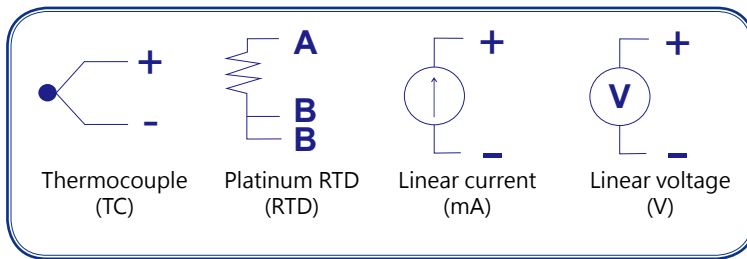

Various Output Modes:

- Relay, voltage pulse, linear voltage, and linear current

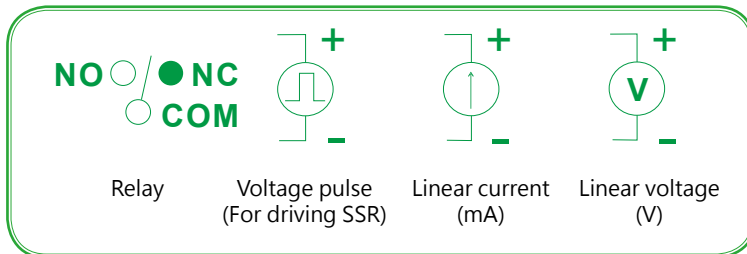

Stable Control:

- Built-in PID control function, with accurate auto-tuning (AT).
- PID parameters are automatically calculated, enhancing the stability of the system and accuracy of control

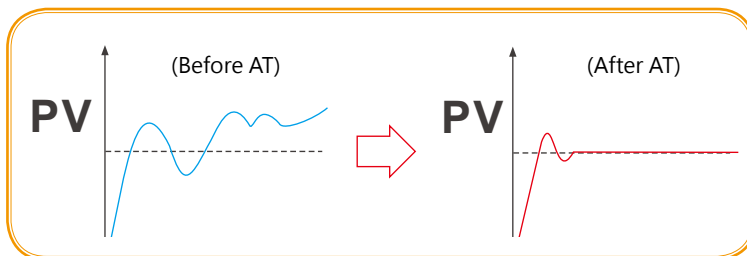

Current Transformer (CT):

- CT can enable the off-line alarm and can detect if the current is overloaded





Programmable Control:

- Max. 8 patterns available, with 8 steps in each pattern.
No master controller is required for planning many kinds of temperature control curves

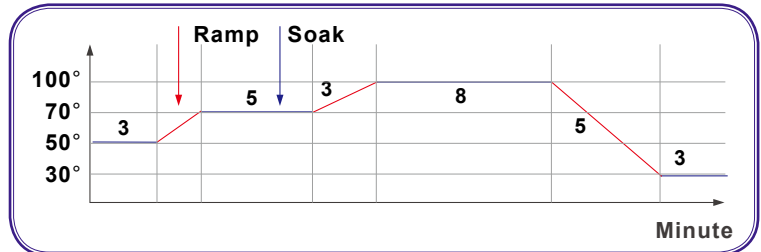

Communication:

- RS-485 communication interface, supporting MODBUS ASCII/RTU communication

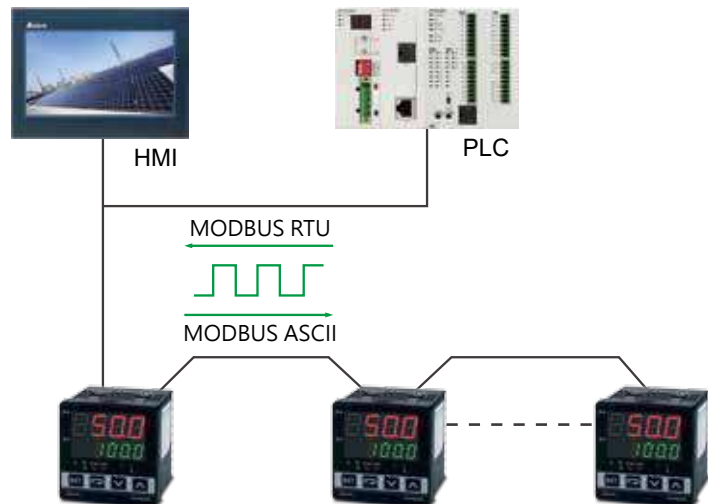

Safety:

- The key-locking function and communication protection prevents malfunction



Dual Output Control:

- Able to execute heating and cooling controls at the same time, allowing the system to reach the set temperature quickly

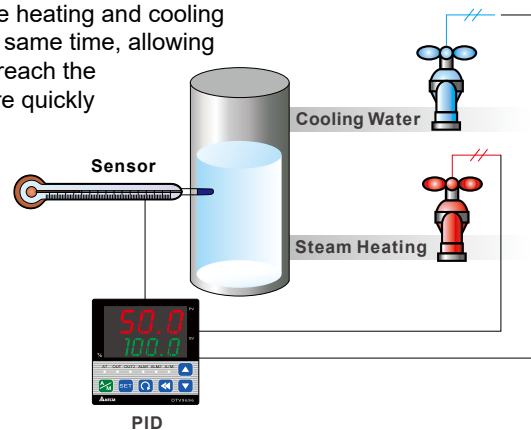

Delta Temperature Controller DT Series

Delta Multi-Loop Modular Temperature Controller DTM

Various input channel, multi-point temperature control, available in RS-485 Type and Ethernet Type



Standard Temperature Controller DTA

Basic single channel input and output



Advanced Temperature Controller DTB

Linear voltage control output and dual-loop control output



Modular Temperature Controller DTC

Side-by-side modular design to monitor multi-points, flexible combination based on output requirements



Valve Controller DTV

Suitable for DTV control applications, easy setting and built-in Modbus for efficient data collection



Multi-Channel Modular Temperature Controller

Supports up to 8 sets of thermocouple or 6 sets of platinum RTD, multiple output modules available



Advanced Intelligent Temperature Controller DT3

Modular design with various control modes and heater disconnection detection function, remote input



Intelligent Temperature Controller DTK

Simple design with high-speed data collection for basic application



Products

DT3 High Speed Intelligent Temperature Controller

The Delta temperature controller DT3 series is designed with upgraded hardware and higher specifications as well as smart operation, fast response, easy modularization, plus user-friendly and user-defined function keys. With Self-Tuning and FUZZY temperature control functions, controllers can be installed in open space and confined space applications and are capable of presenting a smooth temperature control curve. In addition, the innovative design enables customers to replace the module with new functions to attain the ultimate in extension flexibility.



Remote Control

Sets DT3 temperature via analog output of host controller

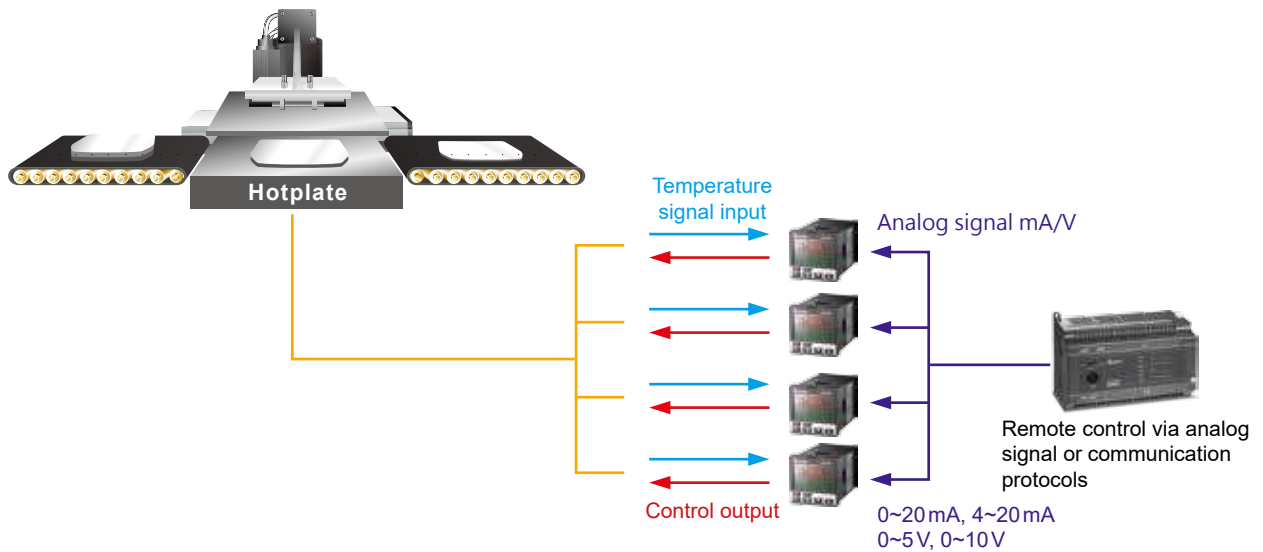

Various Control Modes

- ▶ Auto Tuning
- ▶ FUZZY
- ▶ Manual
- ▶ ON/OFF
- ▶ PID Process Control
- ▶ Self Tuning

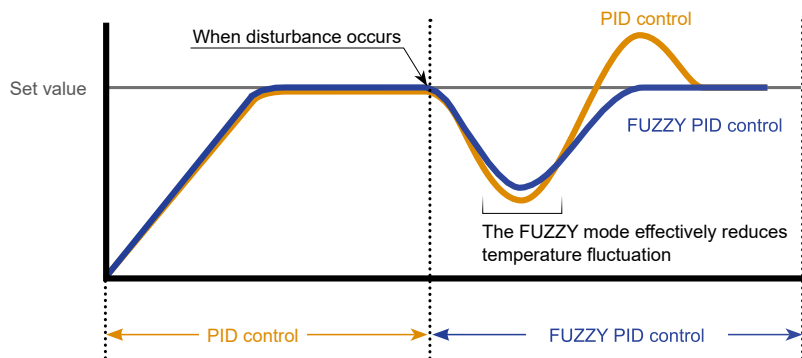

■ Extension Ability

Modular design of functional devices lets users replace the module as needed for application flexibility



■ Large Tri-color LCD Display

The 1st Tri-color LCD temperature controller in Taiwan.



■ Heater Disconnection Detection

Measurable up to 100A

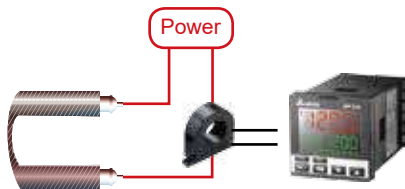

■ Retransmission Output

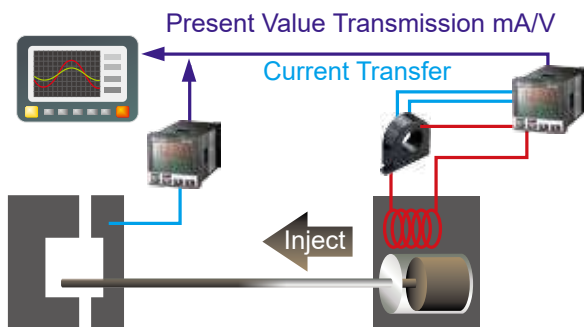

■ User-defined Function Keys

- ▶ Menu
- ▶ Auto-tuning
- ▶ Control modes selection
- ▶ RUN/STOP Mode
- ▶ Program hold



■ Point-to-point Control (Proportional Output mA/V)

Sets the Present Value by point-to-point control.



■ Dual Output Control

- ▶ Preset temperature is rapidly attained using two sets of outputs for heating and cooling control
- ▶ This function is used to automatically calculate two sets of PID parameters, one for heating and one for cooling

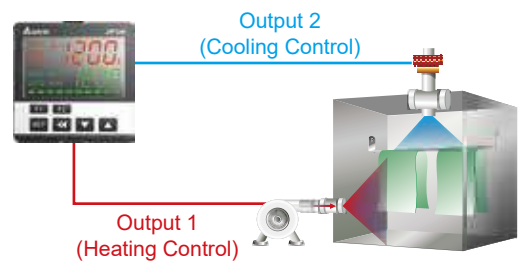

Specifications

Input power supply	100 to 240V _{AC} , 50/60Hz, 24V _{DC} ±10%
Display method	LCD. Present Value: Orange, Set Value: green
Input sensors	Thermocouple: K, J, T, E, N, R, S, B, L, U, TXK
	Platinum RTD: Pt100, JPt100; RTD: Cu50, Ni120
	Analog input: 0 to 5 V, 0 to 10 V, 0 to 20 mA, 4 to 20 mA, 0 to 50 mV
Control modes	PID, PID programmable, FUZZY, Self-tuning, manual, ON/OFF
Display accuracy	0 or 1 digit to the right of the decimal point
Sampling rate	Analog input: 0.1s, Thermocouple or platinum RTD: 0.1s
Operating Ambient Temperature	0 ~ +50°C
Operating Relative Humidity	35 to 80% RH (non-condensing)

Alarm Outputs

The DT3 offers 3 alarm outputs, and each alarm output has 18 alarm modes to choose from in the initial setting mode. When the target temperature exceeds or falls below the set point, the alarm output is enabled.

SV	Alarm Mode	Alarm Output Operation
0	Alarm function disabled	
1	Deviation upper- and lower-limit: This alarm output operates when PV value is higher than the set value SV + (AL - H) or lower than the set value SV - (AL - L).	
2	Deviation upper-limit: This alarm output operates when PV value is higher than the set value SV + (AL - H).	
3	Deviation lower-limit: This alarm output operates when PV value is lower than the set value SV - (AL - L).	
4	Absolute value upper- and lower-limit: This alarm output operates when PV value is higher than the set value AL-H or lower than the set value AL - L.	
5	Absolute value upper-limit: This alarm output operates when PV value is higher than the set value AL - H.	
6	Absolute value lower-limit: This alarm output operates when PV value is lower than the set value AL - L.	
7	Hysteresis upper-limit alarm output: This alarm output operates if PV value is higher than the set value SV + (AL - H). This alarm output is OFF when PV value is lower than the set value SV + (AL - L).	
8	Hysteresis lower-limit alarm output: This alarm output operates if PV value is lower than the set value SV - (AL - H). This alarm output is OFF when PV value is higher than the set value SV - (AL - L).	
9	Disconnection Alarm: This alarm output operates if the sensor connection is incorrect or has been disconnected.	
11	CT1 Alarm: CT1 is ON if the value of CT1 is lower than the value of AL - L or higher than AL - H.	
12	CT2 Alarm: CT2 is ON if the value of CT2 is lower than the value of AL - L or higher than AL - H.	
13	When SOAK status (temperature hold) happens to PID program control, alarm output is ON.	
14	When RAMP UP status happens to PID program control, alarm output is ON.	
15	When RAMP DOWN status happens to PID program control, alarm output is ON.	
16	When RUN status happens to PID program control, alarm output is ON.	
17	When HOLD status happens to PID program control, alarm output is ON.	
18	When STOP status happens to PID program control, alarm output is ON.	
19	When END status happens to PID program control, alarm output is ON.	

RS-485 Communication

DT3 supports baudrate 2,400 to 38,400 bps, MODBUS ASCII/RTU protocol, function code 03H and reads maximum 8 words from the register.

Address	Content	Definition
1000H	Present value (PV)	Measuring unit: 0.1 scale. The following values read mean error occurs. 8002H: Temperature not yet acquired 8003H: Not connected to sensor 8004H: Incorrect sensor
1001H	Set value (SV)	Measuring unit: 0.1 scale
1002H	Upper limit of temp. range	Cannot exceed the default value
1003H	Lower limit of temp. range	Cannot fall below the default value
1005H	Control mode	0: PID, 1: ON/OFF, 2: Manual, 3: FUZZY
1006H	Heating/ Cooling control	0: Heating/Heating, 1: Cooling/Heating, 2: Heating/Cooling, 3: Cooling/Cooling
1007H	1 st Heating/ Cooling control cycle	0.1 ~ 99 sec.
1008H	2 nd Heating/ Cooling control cycle	0.1 ~ 99 sec.
1009H	Proportional band (PB)	0.1 ~ 999.9
100AH	Ti value	0 ~ 9999
100BH	Td value	0 ~ 9999
1012H	Read/write Output 1 volume	Unit: 0.1%, only valid in manual control mode
1013H	Read/write Output 2 volume	Unit: 0.1%, only valid in manual control mode
1016H	Regulated temp. value	-99.9 ~ +99.9, Unit: 0.1
102AH	Read/write LED status	b0: ALM3, b1: ALM2, b2: °F, b3: °C, b4: ALM1, b5: OUT2, b6: OUT1, b7 : AT
102BH	Read/write key status	b0: Set, b1: Select, b2: Up, b3: Down, 0: Press it
102CH	Panel lockup status	0: Normal, 1: Fully locked, 11: SV adjustable
102DH	CT value	Unit: 0.1A
103BH	AT setting	0: OFF (default), 1: ON
103CH	Control RUN/STOP setting	0: STOP, 1: RUN (default), 2: END (program), 3: HOLD (program)



Parameters Operation

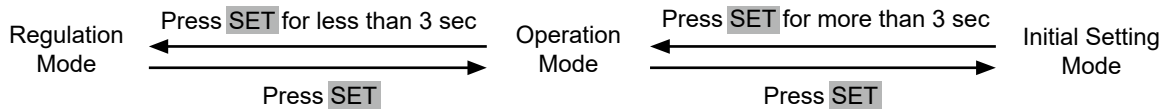

Regulation Mode	Operation Mode	Initial Setting Mode
AL Auto-tuning (when CTRL set in PID or FUZZY and in RUN mode) Press ◀ ▽	T34 Use ▲ ▼ to set up target temperature Press ◀ ▽	INPE Set up input type Press ◀ ▽
SE Self-tuning switch (set when in PID control and the TUNE parameter = ST)	R-S Control loop RUN or STOP	EPUN Set up temperature unit (not displayed when in analog input)
PcD Select the nth (n = 0 ~ 5) PID. When n = 6, PID is auto-selected.	PERN Set up start pattern (when in PID programmable control and PSLP)	EP-H Set up upper temperature limit
Pdof Set up PID control offset	SEEP Set up start step (when in programmable control)	EP-L Set up lower temperature limit
FZ-R Set up FUZZY gain value	SP Set up the position of decimal point	CTRL Select control modes
FZdb Set up FUZZY Deadband	LoL Lock the keys	CTRLS Select SV control modes
o1-S Adjust Output 1 hysteresis (when in ON/OFF control)	AL1H Set up upper limit of Alarm 1	WESV Set up waiting temperature (when in programmable control)
o2-S Adjust Output 2 hysteresis (when in ON/OFF control)	AL1L Set up lower limit of Alarm 1	W-EN Set up waiting time (when in programmable control)
o1-H o1-L Control cycle for Output 1 (except in ON/OFF control)	AL2H Set up upper limit of Alarm 2	SLoP Set up start slope (when in programmable control)
o2-H o2-L Control cycle for Output 2 (except in ON/OFF control)	AL2L Set up lower limit of Alarm 2	PR-EN Select pattern to be edited
CoEF Ratio of Output 1 against Output 2 when in dual output control (set when in PID and dual output control)	AL3H Set up upper limit of Alarm 3	EUNE Select AT or ST
deAd Set up deadband (when in dual output)	AL3L Set up lower limit of Alarm 3	S-HC Select heating, cooling or dual output heating and cooling
PV-F Set up input filter factor	AL1HP Record highest temperature of Alarm 1	AL1A AL2A AL3A Set up Alarm 1 mode
PV-R Set up input filter range	AL1LP Record lowest temperature of Alarm 1	AL1o AL2o AL3o Set up Alarm 1 options
PVoF Adjust input compensation	AL2HP Record highest temperature of Alarm 2	AL1d AL2d AL3d Set up Alarm 1 delay
PVGR Adjust input gain	AL2LP Record lowest temperature of Alarm 2	o-EN Set up reverse alarm output
SUSL Set up rising slope (when CRTS = SLOP)	AL3HP Record highest temperature of Alarm 3	RMEF Set up Remote type
ALMR Adjust upper limit compensation for analog Output 1*	AL3LP Record lowest temperature of Alarm 3	EXEC Select auxiliary function

Regulation Mode	Operation Mode	Initial Setting Mode
RLM1 Adjust lower limit compensation for analog Output 1*	oU1 Display and adjust Output 1 volume	CoSH Enable/disable communication write-in
RLM2 Adjust upper limit compensation for analog Output 2*	oU2 Display and adjust Output 2 volume	C-SL Select ASCII or RTU format
RLM1 Adjust lower limit compensation for analog Output 2*	o1MA Set up upper limit percentage for Output 1	C-Ad Set up communication address
RLM2 Adjust upper limit compensation for Retransmission*	o1ML Set up lower limit percentage for Output 1	bPS Set up baudrate
RLM1 Adjust lower limit compensation for Retransmission*	o2MR Set up upper limit percentage for Output 2	LEN Set up data length
RLM2 Adjust Remote gain	o2ML Set up lower limit percentage for Output 2	StoP Set up stop bit
RLM-F Adjust Remote compensation	CL1 Display current measured at CT1	PRLY Set up parity bit
EV1 Set up EVENT1 function	CL2 Display current measured at CT2 Press ◀ to return to set up target temperature	Press ◀ to return to set up input type
EV2 Set up EVENT2 function		
EV3 Set up EVENT3 function Press ◀ to return to auto-tuning		

*1 scale = 2μA; 1 scale = 1mV

PID mode: Any of the 6 PID groups can be selected. When n = 6, the program will automatically select the PID group that is the closest to the target temperature.

PcD Select the nth PID (n = 0 ~ 5) Press ◀ ▷ 0 ~ 5 th PID	SP0 Set up the 0 th PID temperature value Press ◀ ▽	SP5 Set up the 5 th PID temperature value Press ◀ ▽
	P0 Set up the 0 th proportional band value	P5 Set up the 5 th proportional band value
	T0 Set up the 0 th Ti value	T5 Set up the 5 th Ti value
	d0 Set up the 0 th Td value	d5 Set up the 5 th Td value
	CoFD Set up the 0 th PID integral deviation Press ◀ to return to PID deviation	CoFS Set up the 5 th PID integral deviation Press ◀ to return to PID deviation

Patterns and steps: Edit **PRoB** in **CLRL** parameter. Take editing pattern 0 for example:

PLRM Select the pattern number to be edited Select number ▷ Press ◀ ▽ to select OFF	SP00 Edit temperature for Step 0 Press ◀ ▽	PSY0 Select actual number of steps when the program is executing Press ◀ ▽
Exit pattern and step editing and switch to S-HC to continue the setup process	EM00 Edit time for Step 0 (time unit: hr, min)	CYCO Set up additional cycles (0 ~ 99) for the pattern execution
	Set up Step 0 ~ 15 in order	LN0 Set up link pattern. OFF refers to the program end. Press ◀ to return to select the pattern number to be edited
	SP15 Edit temperature for Step 15 EM15 Edit time for Step 15 Press ◀ to set up actual step numbers	

Products

DTK

New generation of intelligent temperature controller

DTK Series is a new temperature controller with a high cost-performance ratio. It greatly decreases development costs and time, and improves the functions of temperature control systems. With a length of only 60mm and high resolution LCD display, it is easy for operators to monitor the temperatures of any environment or occasion.



Features

- ▶ High resolution LCD display
- ▶ Length shortened to 60 mm
- ▶ High speed sampling time 100 ms
- ▶ CE certified, UL

Description



- A** PV : Present Value
- B** SV : Set Value
- C** °C、°F : Celsius , Fahrenheit temperature indicator
- D** 1、2 : ALM1 , ALM2 alarm output indicator
- E** A/M : Auto-tuning and manual modes indicator
- F** OUT1、OUT2 : Output indicator
- G** Select / Set key
- H** Value adjustment key

Electrical Specifications

Power supply	100 ~ 240 V _{AC} , 50/60 Hz
Display	LCD display. PV : red, SV : green
Input temperature sensors	Thermocouple : K, J, T, E, N, R, S, B, L, U, TXK
	Platinum RTD : Pt100, JPt100
	RTD : Cu50, Ni120
Control methods	ON/OFF, PID, Manual
Display scale	1 digit after decimal point, or no decimal point
Sampling rate	Thermocouple or platinum RTD : 0.1 second
Ambient temperature	0 ~ +50 °C
Ambient humidity	35 ~ 80% RH (non-condensing)

Alarm Outputs

The DTK Series offers 2 alarm outputs, and each alarm output has 9 alarm modes to choose from in the initial setting mode. When the target temperature exceeds or falls below the set point, the alarm output is enabled.

SV	Alarm Mode	Alarm Output Operation
0	Alarm function disabled	
1	Deviation upper- and lower-limit : This alarm output operates when PV value is higher than the set value SV + (AL - H) or lower than the set value SV - (AL - L).	
2	Deviation upper-limit : This alarm output operates when PV value is higher than the set value SV + (AL - H).	
3	Deviation lower-limit : This alarm output operates when PV value is lower than the set value SV - (AL - L).	
4	Absolute value upper- and lower-limit : This alarm output operates when PV value is higher than the set value AL - H or lower than the set value AL - L.	
5	Absolute value upper-limit : This alarm output operates when PV value is higher than the set value AL - H.	
6	Absolute value lower-limit : This alarm output operates when PV value is lower than the set value AL - L.	
7	Hysteresis upper-limit alarm output : This alarm output operates if PV value is higher than the set value SV+ (AL - H). This alarm output is OFF when PV value is lower than the set value SV + (AL - L).	
8	Hysteresis lower-limit alarm output : This alarm output operates if PV value is lower than the set value SV - (AL - H). This alarm output is OFF when PV value is higher than the set value SV - (AL - L).	
9	Disconnection alarm : This alarm output operates if the sensor connection is incorrect or has been disconnected.	

Parameters Operation

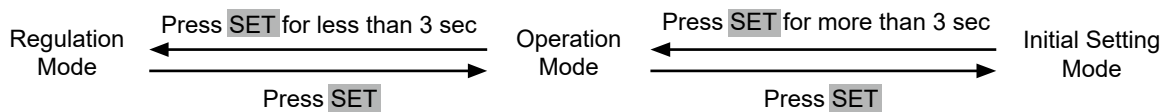

Regulation Mode	Operation Mode	Initial Setting Mode
RL Auto - tuning (when in PID control and RUN mode) Press ∇	1234 Use \blacktriangle \blacktriangledown to set up target temperature Press ∇	Ctrl Set up input type Press ∇
P Set proportion band	r-S Control loop RUN or STOP	EPUn Set up temperature unit
I Set integration time	SP Set up the position of decimal point	EP-H Set up upper temperature limit
d Set derivative time	LoC Lock the keys	EP-L Set up lower temperature limit
Pdof Set up PID control offset	RLIH Set up upper limit of Alarm 1	Ctrl Select control modes
o1-S Adjust Output 1 hysteresis (when in ON / OFF control)	RLIL Set up lower limit of Alarm 1	S-HC Select heating, cooling or dual output heating and cooling
o2-S Adjust Output 2 hysteresis (when in ON / OFF control)	RL2H Set up upper limit of Alarm 2	RLR1 Set up Alarm 1 mode
o1-H OUT1 HEAT: Heating control cycle for Output 1 (when Ctrl = PID/FUZZY/MANUAL)	RL2L Set up lower limit of Alarm 2	RLIo Set up Alarm 1 options *3
o1-C OUT1 COOL: Cooling control cycle for Output 1 (when Ctrl = PID/FUZZY/MANUAL)	oUe1 Display and adjust Output 1 volume	RLId Set up Alarm 1 delay *4
o2-H OUT2 HEAT: Heating control cycle for Output 2 (when Ctrl = PID/FUZZY/MANUAL)	oUe2 Display and adjust Output 2 volume	RLR2 Set up Alarm 2 mode
o2-C OUT2 COOL: Cooling control cycle for Output 2 (when Ctrl = PID/FUZZY/MANUAL)	o1nR Set up upper limit percentage for Output 1	RL2o Set up Alarm 2 options *3
CoEF Ratio of Output 1 against Output 2 when in dual output control (set when in PID control)	o1nc Set up lower limit percentage for Output 1	RL2d Set up Alarm 2 delay *4
dERd Set up deadband	o2nR Set up upper limit percentage for Output 2	
Pu-F Set up input filter factor	o2nc Set up lower limit percentage for Output 2	
Pu-r Set up input filter range		
Puof Adjust input compensation *1		
PuGR Adjust input gain *1		
RLnR Adjust upper limit compensation for analog Output 1 *2		
RLnc Adjust lower limit compensation for analog Output 1 *2 Press to return to auto-tuning	Press to return to set up target temperature	Press to return to set up input type

Parameters Operation

- * Alarm 1 is automatically switched to output control 2 when selecting dual output mode
- * Set up upper / lower limit percentage for output 1 / 2 volume : set output permission ranges. E.g. upper and lower limit percentage are respectively set as 90 and 20, output volume will be limited to 20% ~ 90%.
- *1. Offset Present value : Use P_{offset} and P_{offsetR} .
Present value = measured value $\times (1 + P_{\text{offsetR}}/1.000) + P_{\text{offset}}$.
- *2. 1 scale = 1 μ A
- *3. Set up alarm standby : set corresponding Y value as xxxY (Y = 0 : normal / Y = 1 : standby)
Set up reverse alarm output : set corresponding Y value as xxYx (Y = 0 : forward / Y = 1 : backward)
Set up Hold output : set corresponding Y value as xYxx (Y = 0 : normal / Y = 1 : Hold)
- *4. Set up alarm delay : The alarm operates after reaching alarm delay time (recalculating time if discontinuity occurs in the process)

Temperature Sensors and Temperature Range

Input sensors	Display	Temperature Range	Input sensors	Display	Temperature Range
Platinum RTD: Pt100	PE	-200 ~ 850°C	Thermocouple E	E	0 ~ 600°C
Platinum RTD: JPt100	JPE	-100 ~ 400°C	Thermocouple T	T	-200 ~ 400°C
Copper resistance: Cu50	EU	-50 ~ 150°C	Thermocouple J	J	-100 ~ 850°C
RTD Ni120	nL	-80~300°C	Thermocouple K	K	-200 ~ 1,300°C
Thermocouple B	b	100 ~ 1,800°C	Thermocouple L	L	-200 ~ 850°C
Thermocouple S	S	0 ~ 1,700°C	Thermocouple U	U	-200 ~ 500°C
Thermocouple R	r	0 ~ 1,700°C	Thermocouple Txx	Txx	-200 ~ 800°C
Thermocouple N	n	-200 ~ 1,300°C			

Panel Sizes

Models	Sizes (W × H)
4848	45 mm × 45 mm
4896	44.5 mm × 91.5 mm
7272	68 mm × 68 mm
9696	91.5 mm × 91.5 mm

Terminal Wiring Diagram

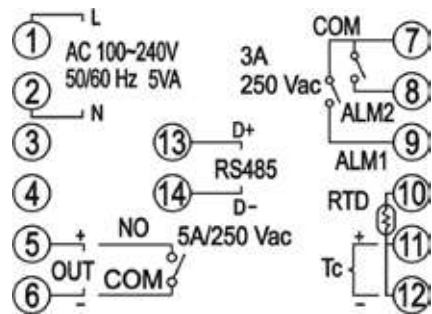

Products

DTA Standard Type

DTA is designed for practical applications, offering the 3 most frequently adopted output types in the market. DTA has many user-friendly functions built-in and a handy transmission structure, ensuring fast and stable data transmission.

Optional functions: RS-485 communication interface (MODBUS ASCII/RTU, 2,400 ~ 38,400 bps), CT (current transformer)



Electrical Specifications

Power supply	100 ~ 240 V _{AC} , 50/60Hz
Voltage range	85 ~ 110% rated voltage
Power consumption	5VA Max.
Display	2-line 7-segment LED display, PV: red; SV: green
Input temperature sensors	Thermocouple: K, J, T, E, N, R, S, B, U, L, TXK
	Platinum RTD: Pt100, JPt100
Display scale	1 digit after decimal point, or no decimal point
Control methods	PID, ON/OFF, Manual
Output types	Relay: 250 V _{AC} , 5A, SPDT (DTA4848: SPST)
	Voltage pulse: 14 V _{DC} , Max. output current: 40 mA
	Current: DC 4 ~ 20 mA (Load resistance: < 600 Ω)
Sampling rate	0.5 second
Communication	RS-485 digital communication, 2,400 ~ 38,400 bps (optional)
Communication protocol	MODBUS protocol, ASCII/RTU format (optional)
Vibration resistance	10 ~ 55Hz, 10 m/s ² for 10 mins in X, Y, Z direction
Shock resistance	Max. 300 m/s ² , 3 times in each of 3 axes, 6 directions
Ambient temperature	0 °C ~ 50 °C
Storage temperature	-20 °C ~ +65 °C
Altitude	< 2,000 m
Ambient humidity	35 ~ 85% RH (non-condensing)
IP Rating (Panel)	IP65

Products

DTB Advanced Type

Compared to the DTA, DTB has an added linear voltage output and adopts dual-loop output control, and is able to execute heating and cooling controls at the same time in a temperature control system.

DTB series has a built-in RS-485 communication interface (MODBUS ASCII/RTU, 2,400 ~ 38,400bps). The programmable PID control function allows the DTB to set up 64 sets of temperature and control times.

Optional functions:

- CT (current transformer), output by alarm.
- EVENT function, switching between 2 SVs by using PLC or switches.
- Valve models are able to adjust the action level of valves depending on the SV.



Electrical Specifications

Power supply	100 ~ 240 V _{AC} , 50/60 Hz; 24 V _{DC} ± 10 %
Voltage range	85 ~ 110% rated voltage
Power consumption	< 5 VA
Display	2-line 7-segment LED display, 4 digits available, PV: red, SV: green
Input temperature sensors	Thermocouple: K, J, T, E, N, R, S, B, L, U, TXK
	Platinum RTD: Pt100, JPt100
	Analog input: 0 ~ 5V, 0 ~ 10V, 0 ~ 20mA, 4 ~ 20mA, 0 ~ 50mV
Display scale	1 digit after decimal point, or no decimal point
Control methods	PID, programmable PID, ON/OFF, Manual
Output types	Relay: SPDT (DTB4848/4824: SPST), Max. load: 250 V _{AC} , Resistive load: 5A
	Voltage pulse: 14 V _{DC} , Max. output current: 40 mA
	Current: DC 4 ~ 20 mA (Load resistance: < 600 Ω)
	Analog voltage: 0 ~ 10V
Sampling rate	Analog input: 0.15 second, Thermocouple or platinum RTD: 0.4 second
Communication	RS-485 digital communication, 2,400 ~ 38,400bps
Communication protocol	MODBUS protocol, ASCII/RTU format
Vibration resistance	10 ~ 55Hz, 10 m/s ² for 10 mins in X, Y, Z direction
Shock resistance	Max. 300 m/s ² , 3 times in each of 3 axes, 6 directions
Ambient temperature	0°C ~ 50°C
Storage temperature	-20°C ~ +65°C
Altitude	< 2,000 m
Ambient humidity	35 ~ 85% RH (non-condensing)
IP Rating (Panel)	IP65

DTC Modular Type

DTC features a modular and wire-saving structure, and is able to monitor many temperature points by parallel and modular extension. The user is able to set up a suitable output method according to actual demand. The built-in password protection prevents unauthorized operation or malicious damage from staff.

DTC series has a built-in RS-485 communication interface (MODBUS ASCII/RTU, 2,400 ~ 38,400bps). The programmable PID control function allows the DTC to set up 64 sets of temperature and control times. DTC also supports 3 levels of password protection, synchronous communication protocol and auto ID setup.



Electrical Specifications

Power supply	24 V _{DC} , isolated switching power supply
Voltage range	90 ~ 110% rated voltage
Power consumption	3 W + 3 W x number of DTC2000 controllers connected in parallel (Max. 7)
Input temperature sensors	Thermocouple: K, J, T, E, N, R, S, B, L, U, TXK
	Platinum RTD: Pt100, JPt100
	Analog input: 0 ~ 5V, 0 ~ 10V, 0 ~ 20mA, 4 ~ 20mA, 0 ~ 50mV
Control methods	PID, programmable PID, ON/OFF, Manual
Output types	Relay: SPST, Max. load: 250 V _{AC} , Resistive load: 3A
	Voltage pulse: 12 V _{DC} , Max. output current: 40 mA
	Current: DC 4 ~ 20 mA (Load resistance: < 500 Ω)
	Analog voltage: 0 ~ 10 V (Load resistance: > 1,000 Ω)
Sampling rate	Analog input: 0.15 second, Thermocouple or platinum RTD: 0.4 second
Communication	RS-485 digital communication, 2,400 ~ 38,400 bps
Communication protocol	MODBUS protocol, ASCII/RTU format
Vibration resistance	10 ~ 55 Hz, 10 m/s ² for 10 mins in X, Y, Z direction
Shock resistance	Max. 300 m/s ² , 3 times in each of 3 axes, 6 directions
Ambient temperature	0 °C ~ 50 °C
Storage temperature	-20 °C ~ +65 °C
Altitude	< 2,000 m
Ambient humidity	35 ~ 85% RH (non-condensing)

Products

DTE Multi-Channel Modular Type

DTE series is a multi-channel modular type temperature controller. The DTE10T supports 8 thermocouple inputs and the DTE10P supports 6 platinum RTD inputs. The DTE series is installed on DIN rail, and each channel operates independently. DTE series offers many optional output modules (relay, voltage pulse, current and linear current). The built-in RS-485 2-wire communication allows transmission of up to 115,200 bps.

The programmable PID control function allows the DTE to set up 64 sets of temperature and control times. Maximum 7 DTC2000 controllers are extendable to DTE, and DTE supports the same synchronous communication protocol and auto ID setup which DTC supports.



Electrical Specifications

Power supply	24 V _{DC} , isolated switching power supply
Voltage range	90 ~ 110% rated voltage
Power consumption	Max. 10W + 3W x number of DTC2000 controllers connected in parallel (Max. 7)
Input temperature sensors	Thermocouple: K, J, T, E, N, R, S, B, L, U, TXK
	Platinum RTD: Pt100, JPt100 RTD: Cu50; Ni120
Control methods	PID, programmable PID, ON/OFF, Manual
Output types	Relay: SPST, Max. load: 250 V _{AC} , Resistive load: 3A
	Voltage pulse: 12 V _{DC} , Max. output current: 40 mA
	Current: DC 4 ~ 20 mA (Load resistance: < 500 Ω)
	Analog voltage: 0 ~ 10 V (Load resistance: > 1,000 Ω)
Sampling rate	Thermocouple or platinum RTD: 1.0 second/all inputs
Communication	RS-485 digital communication, 2,400 ~ 115,200 bps
Communication protocol	MODBUS protocol, ASCII/RTU format
Vibration resistance	10 ~ 55 Hz, 10 m/s ² for 10 mins in X, Y, Z direction
Shock resistance	Max. 300 m/s ² , 3 times in each of 3 axes, 6 directions
Ambient temperature	0 °C ~ 50 °C
Storage temperature	-20 °C ~ +65 °C
Altitude	< 2,000 m
Ambient humidity	35 ~ 85% RH (non-condensing)

DTV **Valve Type**

DTV series is designed for electronic valve applications. It is user-friendly and easy to use. DTV has built-in MODBUS communication, which allows handier data collection.

DTV also features:

- Auto/manual mode switching by a single key
- "Left" key makes the parameter setting faster
- Real-time output percentage display, for the user to check the action level of the valve
- 2 alarm outputs, 17 alarm modes
- RS-485 communication interface for DTV to monitor and collect data from other temperature controllers on the network



Electrical Specifications

Power supply	100 ~ 240 V _{AC} , 50/60 Hz
Voltage range	85 ~ 110% rated voltage
Power consumption	< 5 VA
Display	2-line 7-segment LED display, 4-bit or 2-bit valve action level display available PV: red, SV & action level of valve: green
Input temperature sensors	Thermocouple: K, J, T, E, N, R, S, B, L, U, TXK Platinum RTD: Pt100, JPt100 Analog input: 0 ~ 5 V, 0 ~ 10 V, 0 ~ 20 mA, 4 ~ 20 mA, 0 ~ 50 mA
Display scale	1 digit after decimal point, or no decimal point
Control methods	PID, programmable PID, ON/OFF, Manual
Output types	Relay: SPST, Max. load: 250 V _{AC} ; resistive load: 5 A Current: DC 4 ~ 20 mA
Sampling rate	Analog input: 0.15 second; thermocouple or platinum RTD: 0.4 second
Communication	RS-485 digital communication, 2,400 ~ 38,400 bps
Communication protocol	MODBUS protocol, ASCII/RTU format
Vibration resistance	10 ~ 55 Hz, 10 m/s ² for 10 mins in X, Y, Z direction
Shock resistance	Max. 300 m/s ² , 3 times in each of 3 axes, 6 directions
Ambient temperature	0 °C ~ 50 °C
Storage temperature	-20 °C ~ +65 °C
Altitude	< 2,000 m
Ambient humidity	35 ~ 85% RH (non-condensing)
IP Rating (Panel)	IP65

Ordering Information

DT3

1 2 3 4 5 6 7 8

Series Name		Delta DT3 Series Temperature Controller	
1 2	Panel size (W x H)	20: 4848: 1/16 DIN W48 x H48 mm 30: 7272: W72 x H72 mm	40: 4896: 1/8 DIN W48 x H96 mm 60: 9696: 1/4 DIN W96 x H96 mm
3	Output 1 options	R: Relay, 250 V _{AC} , 5A V: Voltage pulse, 12V +10 to 20%	C: DC current, 4 to 20mA L: Linear voltage, 0 to 10 V _{DC}
4	Power supply	A: AC 100 to 240V D: DC 24V	
5	Output 2 options	R: Relay, 250 V _{AC} , 5A V: Voltage pulse, 12V +10 to 20%	C: DC current, 4 to 20 mA L: Linear voltage, 0 to 10 V _{DC}
6	Optional function 1	0: None, 1: Event input 3, 2: RS-485 communication	
7	Optional function 2	0: None, 1: Event input 2, 2: CT input 2, 3: Retransmission output	
8	Optional function 3	0: None, 1: Event input 1, 2: CT input 1, 3: Remote setup input	

DT3 Accessories

D T 3 - 1

Accessories		Delta DT3 Series Temperature Controller	
1	Option 1	20ESTD: DT320 EXTENSION without RS-485 & EV3	R: Relay Output
		20ECOM: DT320 EXTENSION include RS-485	V: DC Voltage Pulse Output
		20EEV3: DT320 EXTENSION include EVENT3	C: DC Current Output
		40ESTD: DT340/DT360 EXTENSION without RS-485 & EV3	L: DC Linear Voltage Output
		40ECOM: DT340/360 EXTENSION include RS-485	EVENT: Event Input
		40EEV3: DT340/360 EXTENSION include EVENT3	CTI: CT Input
		DT330 is a replacement for DTA7272 (with basic function). It has less extension function. <ul style="list-style-type: none"> DT330 □ A-0 has 1 output, 1 alarm output, and has no extension functions DT330 □ A has 1 output, 2 alarm outputs, but no extension functions (similar to DTA7272 □ 0) DT330 □ A-0200 has 1 output, 2 alarm outputs, and has no extension functions. It supports RS-485 communication function (similar to DTA7272 □ 1) 	
		REMOTE: Remote set point	
		CT30A: 30A CT	
		CT100A: 100A CT	



DTK

1 2 3 4 5 6 7

Series Name		Delta DTK Series Temperature Controller	
1 2 3 4	Panel size (W x H)	4848: W48 × H48 mm 4896: W48 × H96 mm	7272: W72 × H72 mm 9696: W96 × H96 mm
5	Output options	R: Relay, 250 V _{AC} , 5 A V: Voltage Pulse, 12 V _{DC} +10~20%	C: DC Current Output 4 ~ 20mA
6	Optional function	0: N/A	1: RS-485 communication
7	Optional function	1: 1 Alarm output	2: 2 Alarm outputs

DTA

1 2 3 4 5 6 - 7

Series Name		Delta DTA Series Temperature Controller	
1 2 3 4	Panel size (W x H)	4848: 1/16 DIN W48 x H48 mm 4896: 1/8 DIN W48 x H96 mm 9696: 1/4 DIN W96 x H96 mm	7272: W72 x H72 mm 9648: W96 x H48 mm
5	Output	R: Relay, SPST (4848: SPST), 250 V _{AC} , 5 A V: Voltage pulse, 14V +10% ~ -20% (Max. 40mA)	C: Current, 4~20mA
6	Communication (optional)	0: N/A	1: RS-485 communication
7	CT (optional)	<input type="checkbox"/> : N/A	T: With CT (only DTA7272R0)

DTB

1 2 3 4 5 6 7

*DTB4824 has no optional function and no extra alarm output. Output 2 can be set to alarm output.
*DTB4848 has only 1 optional alarm output. Output 2 can be set to the 2nd alarm output.
*DTB9696 has optional valve control function. Model name: DTB9696RRV.

Series Name		Delta DTB Series Temperature Controller	
1 2 3 4	Panel size (W x H)	4824: 1/32 DIN W48 x H24 mm 4848: 1/16 DIN W48 x H48 mm	4896: 1/8 DIN W48 x H96 mm 9696: 1/4 DIN W96 x H96 mm
5	Output 1 options	R: Relay, SPDT (4824/4848: SPST), 250 V _{AC} , 5A V: Voltage pulse: 14V +10% ~ -20% C: DC current: 4 ~ 20mA L: Linear voltage: 0 ~ 5V, 0 ~ 10 V _{DC}	
6	Output 2 options	R: Relay, SPDT (4824/4848: SPST), 250 V _{AC} , 5A V: Voltage pulse: 14V +10% ~ -20%	
7	Optional function	<input type="checkbox"/> : Without CT, without EVENT input T: With CT, without EVENT input	E: Without CT, with EVENT input V: Valve control



DTC

1 2 3 4 5

Series Name		Delta DTC Series Temperature Controller
1	Controller type	1: Main unit 2: Extension unit
2	Number of auxiliary outputs	0: Standard 2 outputs, no auxiliary output
3 4	Optional function	00: Standard function 01: With CT input
5	Output	R: Relay, SPST, 250 V _{AC} , 3A V: Voltage pulse, 12V +10% ~ -20% C: Current, 4 ~ 20mA L: Linear voltage, 0 ~ 10V

DTE

1 2 3

Series Name		Delta DTE Series Temperature Controller
1	Controller type	1: Main unit 2: Accessory
2 3	Optional function	0T: 4-channel TC (main unit, accessory) 0R: 4 channels of relay output 0P: 3-channel PT (main unit, accessory) 0L: 4 channels of linear voltage output 0V: 4 channels of voltage pulse output 0D: 4 digital inputs & 4 digital outputs 0C: 4 channels of linear current output CT: 4 channels of current transformers DS: Display & setup module

DTV

1 2 3 4 5

Series Name		Delta DTV Series Temperature Controller
1 2 3 4	Panel size (W x H)	4896: 1/8 DIN W48 x H96 mm 9696: 1/4 DIN W96 x H96 mm
5	Output	R: Relay, SPDT, 250 V _{AC} , 5A C: DC current: 4 ~ 20mA



Dimensions

DTB

4824

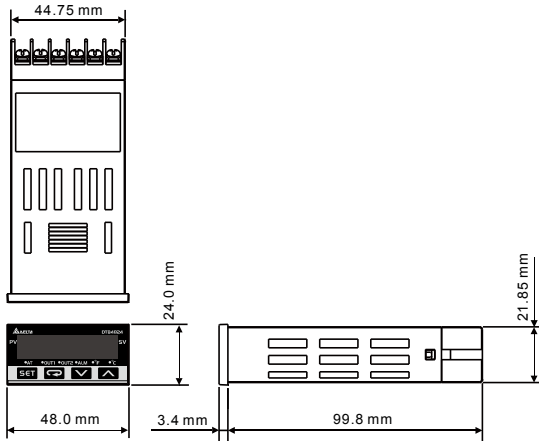

4848

Unit: mm

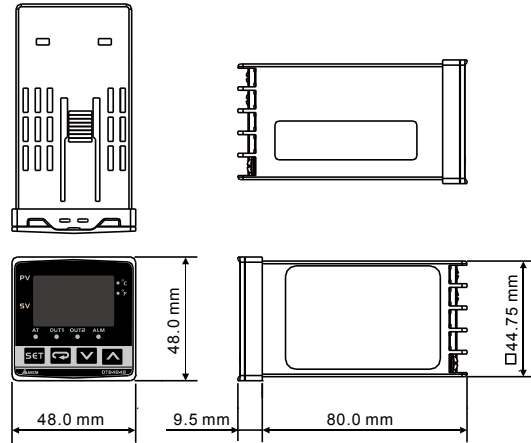

4896

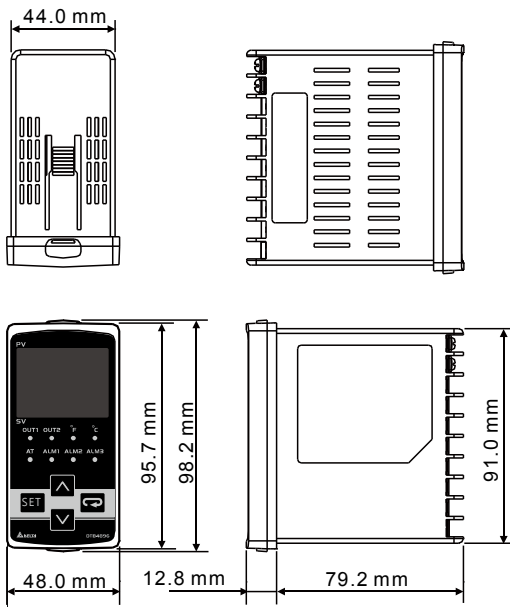

9696

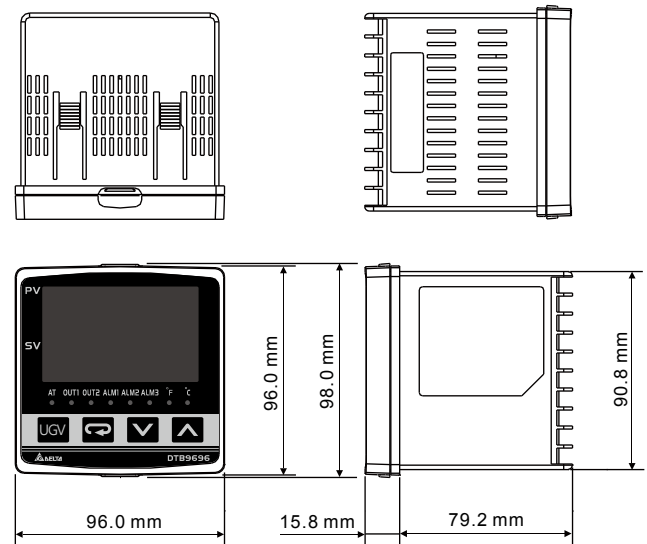

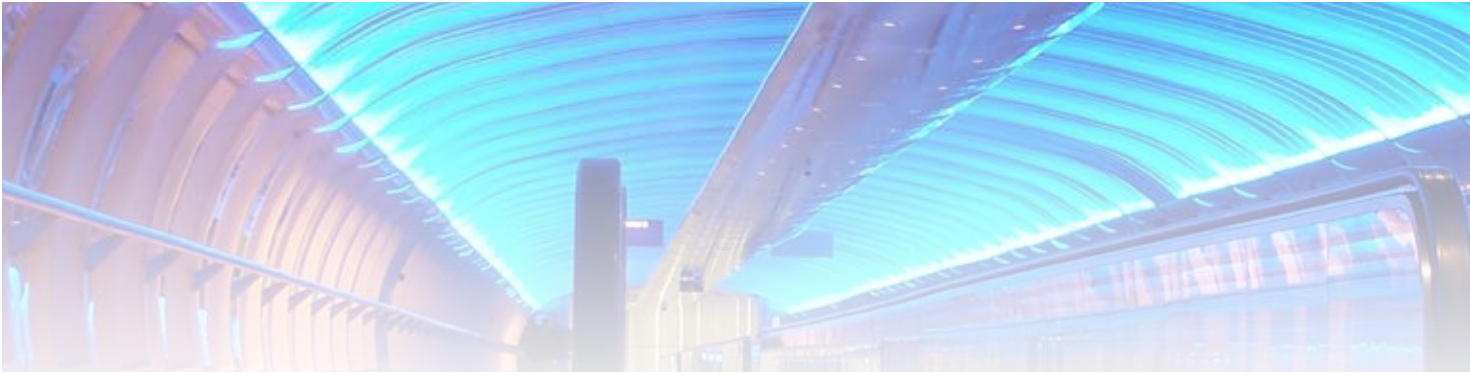

DTA 7272

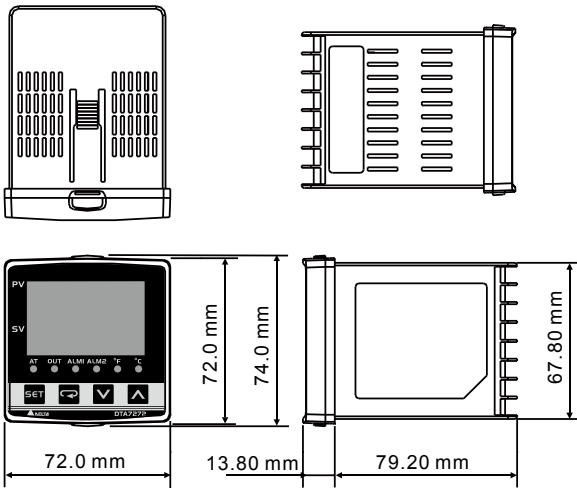

9648

Unit: mm

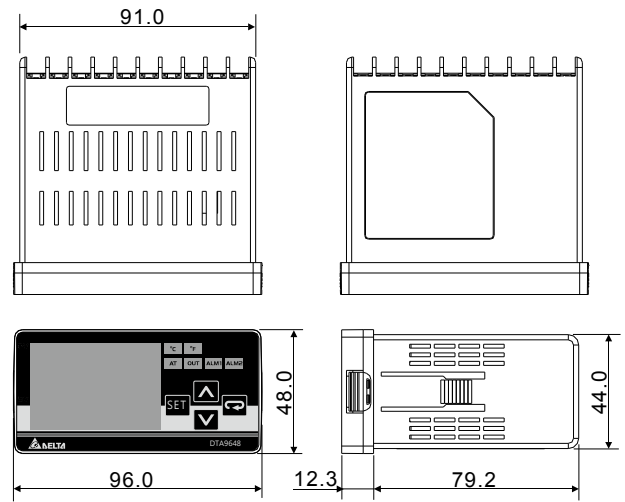

DTC

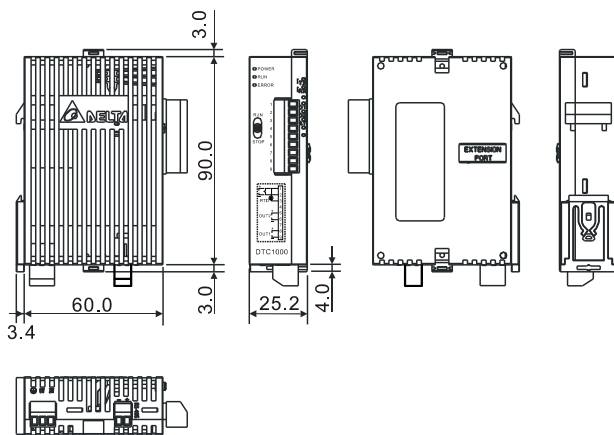

DTE

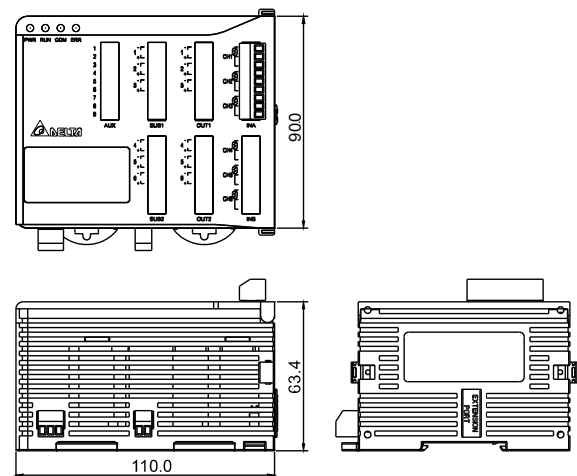



DT3

320

330

CT30A

Unit: mm

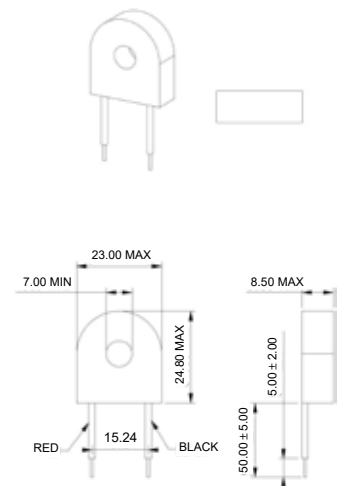
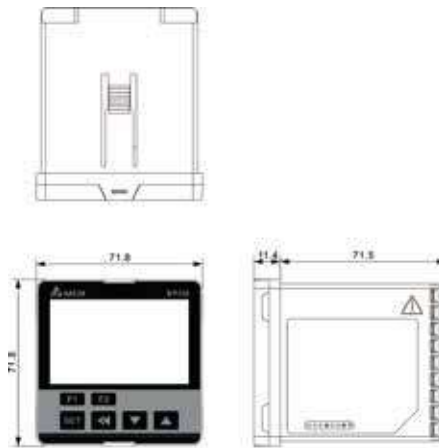
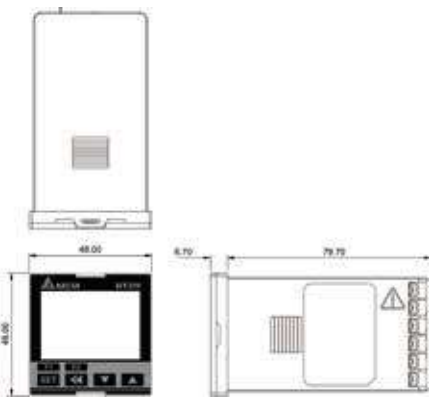

340

360

CT100A

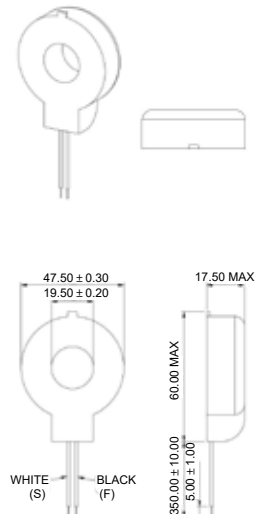
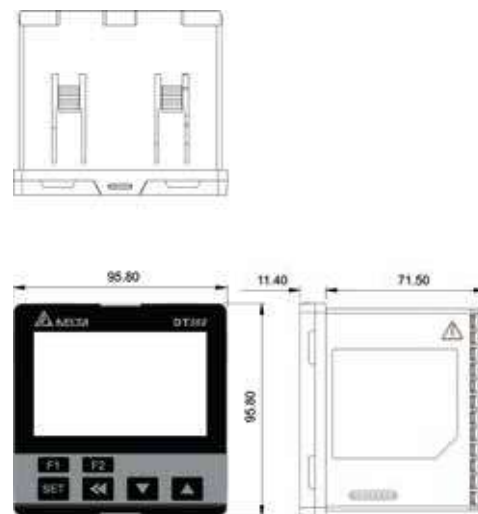
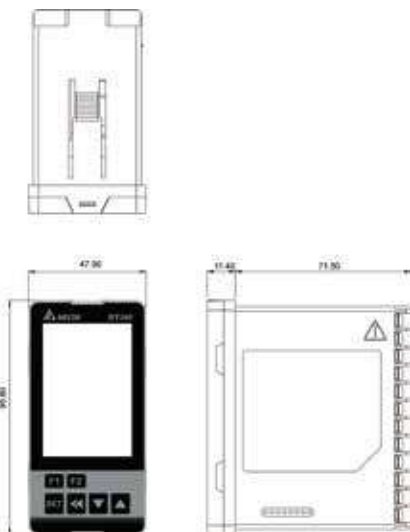



DTK

4848

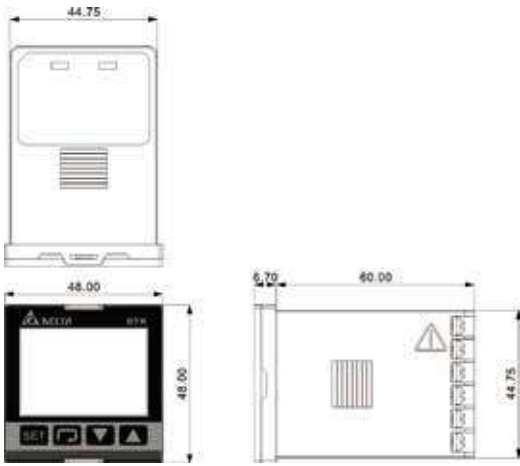

4896

Unit: mm

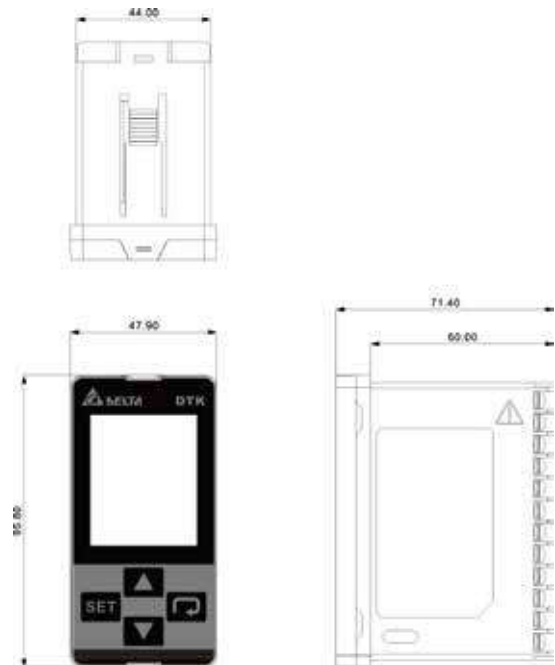

7272

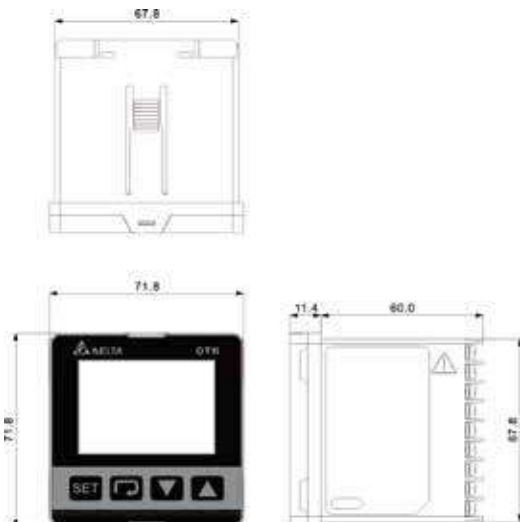

9696

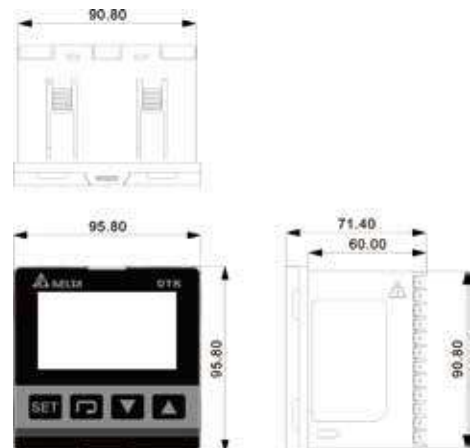



Smarter. Greener. Together.

Industrial Automation Headquarters

Delta Electronics, Inc.

Taoyuan Technology Center
No.18, Xinglong Rd., Taoyuan District,
Taoyuan City 33068, Taiwan
TEL: 886-3-362-6301 / FAX: 886-3-371-6301

Asia

Delta Electronics (Shanghai) Co., Ltd.

No.182 Minyu Rd., Pudong Shanghai, P.R.C.
Post code : 201209
TEL: 86-21-6872-3988 / FAX: 86-21-6872-3996
Customer Service: 400-820-9595

Delta Electronics (Japan), Inc.

Tokyo Office
Industrial Automation Sales Department
2-1-14 Shibadaimon, Minato-ku
Tokyo, Japan 105-0012
TEL: 81-3-5733-1155 / FAX: 81-3-5733-1255

Delta Electronics (Korea), Inc.

Seoul Office
1511, 219, Gasan Digital 1-Ro., Geumcheon-gu,
Seoul, 08501 South Korea
TEL: 82-2-515-5305 / FAX: 82-2-515-5302

Delta Energy Systems (Singapore) Pte Ltd.

4 Kaki Bukit Avenue 1, #05-04, Singapore 417939
TEL: 65-6747-5155 / FAX: 65-6744-9228

Delta Electronics (India) Pvt. Ltd.

Plot No.43, Sector 35, HSIIDC Gurgaon,
PIN 122001, Haryana, India
TEL: 91-124-4874900 / FAX : 91-124-4874945

Delta Electronics (Thailand) PCL.

909 Soi 9, Moo 4, Bangpoo Industrial Estate (E.P.Z),
Pattana 1 Rd., T.Phraksa, A.Muang,
Samutprakarn 10280, Thailand
TEL: 66-2709-2800 / FAX : 662-709-2827

Delta Energy Systems (Australia) Pty Ltd.

Unit 20-21/45 Normanby Rd., Notting Hill Vic 3168, Australia
TEL: 61-3-9543-3720

Americas

Delta Electronics (Americas) Ltd.

Raleigh Office
P.O. Box 12173, 5101 Davis Drive,
Research Triangle Park, NC 27709, U.S.A.
TEL: 1-919-767-3813 / FAX: 1-919-767-3969

Delta Greentech (Brasil) S/A

São Paulo Office
Rua Itapeva, 26 – 3º Andar - Bela Vista
CEP: 01332-000 – São Paulo – SP - Brasil
TEL: 55-11-3530-8642 / 55-11-3530-8640

Delta Electronics International Mexico S.A. de C.V.

Mexico Office
Vía Dr. Gustavo Baz No. 2160, Colonia La Loma,
54060 Tlalnepanlta Estado de Mexico
TEL: 52-55-2628-3015 #3050/3052

EMEA

Headquarters: Delta Electronics (Netherlands) B.V.

Sales: Sales.IA.EMEA@deltaww.com
Marketing: Marketing.IA.EMEA@deltaww.com
Technical Support: iatechnicalsupport@deltaww.com
Customer Support: Customer-Support@deltaww.com
Service: Service.IA.emea@deltaww.com
TEL: +31(0)40 800 3800

BENELUX: Delta Electronics (Netherlands) B.V.

De Witbogt 20, 5652 AG Eindhoven, The Netherlands
Mail: Sales.IA.Benelux@deltaww.com
TEL: +31(0)40 800 3800

DACH: Delta Electronics (Netherlands) B.V.

Coesterweg 45, D-59494 Soest, Germany
Mail: Sales.IA.DACH@deltaww.com
TEL: +49(0)2921 987 0

France: Delta Electronics (France) S.A.

ZI du bois Challand 2, 15 rue des Pyrénées,
Lisses, 91090 Evry Cedex, France
Mail: Sales.IA.FR@deltaww.com
TEL: +33(0)1 69 77 82 60

Iberia: Delta Electronics Solutions (Spain) S.L.U

Ctra. De Villaverde a Vallecas, 265 1º Dcha Ed.
Hormigueras – P.I. de Vallecas 28031 Madrid
TEL: +34(0)91 223 74 20

Carrer Llacuna 166, 08018 Barcelona, Spain

Mail: Sales.IA.Iberia@deltaww.com

Italy: Delta Electronics (Italy) S.r.l.

Ufficio di Milano Via Senigallia 18/2 20161 Milano (MI)
Piazza Grazioli 18 00186 Roma Italy
Mail: Sales.IA.Italy@deltaww.com
TEL: +39 02 64672538

Russia: Delta Energy System LLC

Vereyskaya Plaza II, office 112 Vereyskaya str.
17 121357 Moscow Russia
Mail: Sales.IA.RU@deltaww.com
TEL: +7 495 644 3240

Turkey: Delta Greentech Elektronik San. Ltd. Sti. (Turkey)

Şerifaii Mah. Hendem Cad. Kule Sok. No:16-A
34775 Ümraniye – İstanbul
Mail: Sales.IA.Turkey@deltaww.com
TEL: + 90 216 499 9910

GCC: Delta Energy Systems AG (Dubai BR)

P.O. Box 185668, Gate 7, 3rd Floor, Hamarain Centre
Dubai, United Arab Emirates
Mail: Sales.IA.MEA@deltaww.com
TEL: +971(0)4 2690148

Egypt + North Africa: Delta Electronics

511 Cairo Business Plaza, North 90 street,
New Cairo, Cairo, Egypt
Mail: Sales.IA.MEA@deltaww.com